

loveⁿcare™

HK801



CAYENNE GLIDER CHAIR

PLEASE KEEP THESE INSTRUCTIONS FOR FUTURE REFERENCE

love^hcare™

Congratulations on your purchase of the Cayenne glider chair.

This product has been designed and developed with safety, comfort and functionality in mind. Please take the time to read this manual carefully before using this product and keep it in a safe place for future reference

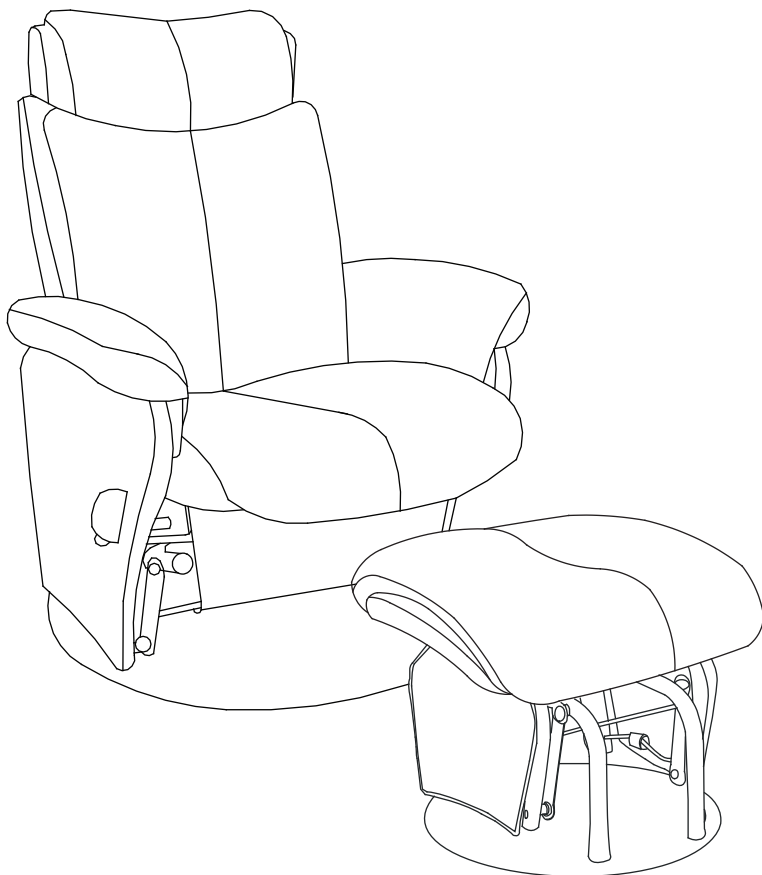



WARNING

Adult assembly required:

- Due to the presence of small parts during assembly, keep out of reach of children until assembly is complete

Crush and amputation hazards:

- A child's hands can be trapped in moving parts of the rocker chair or ottoman.
- Always ensure child's hands are clear from moving parts of the rocker chair or Ottoman.
- Ensure the fabric covers over the chair and Ottoman bases are fitted at all times
- Care should be taken as the underside mechanism of this glider could present a hazard to other people when in use
- The footstool is intended to be used for supporting the feet and legs only, not for sitting on
- Do not sit on the edge of the seat, armrests or on the backrest as this could cause the chair to tip over
- Do not use the chair as a step stool
- Do not leave children unattended on or beside the glider and foot stool.

MAX WEIGHT: 105KG

CARE AND MAINTENANCE

Cleaning







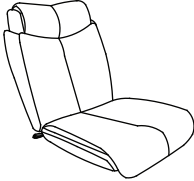
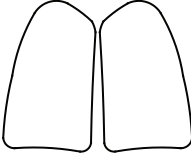
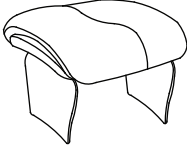

To ensure the long-lasting use of your rocker chair, wipe down with a damp cloth and use a mild soap solution if necessary. Do not use abrasive cleaners. Always store product in a clean dry place.

Maintenance

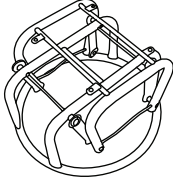
Always check parts regularly for tightness of screws, nuts and other fasteners – tighten or replace if required. To maintain the safety of your rocker chair, seek prompt repairs for bent, torn, worn or broken parts. Use only those parts and accessories approved by Love N Care. If any parts are broken or lost please discontinue using and contact Love N Care for replacement parts or repairs on 1300 732 599

Parts

Please check the contents of the box against the list below. If anything is missing, please contact Love N Care on 1300 732 599.

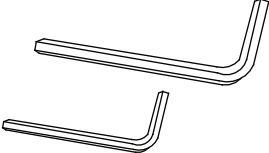
| | | |
|---|--|--|
| 1. 1 PC  | 2. 1(R) + 1(L)  | 3. 1 PC  |
| 4. 1PC  | 5. 1PC  | 6. 2 PCS  |
| 7. 4PCS  | 8. 4PCS  | 9. 2 PCS  |
| 10. 4 PCS  | 11. 4 PCS  | 12 & 13. 1 PC  |

Assembly

ASSEMBLING FRAME

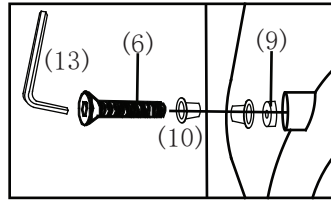
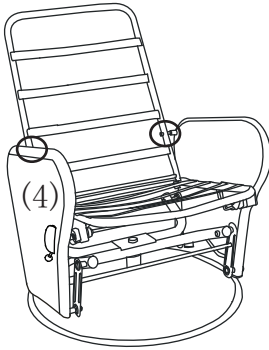

ASSEMBLING FRAME + ATTACHING SEAT LINER

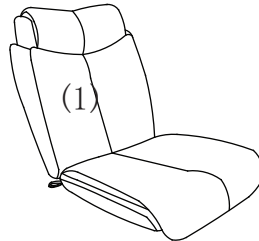
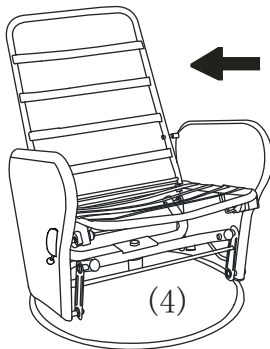

Assembly

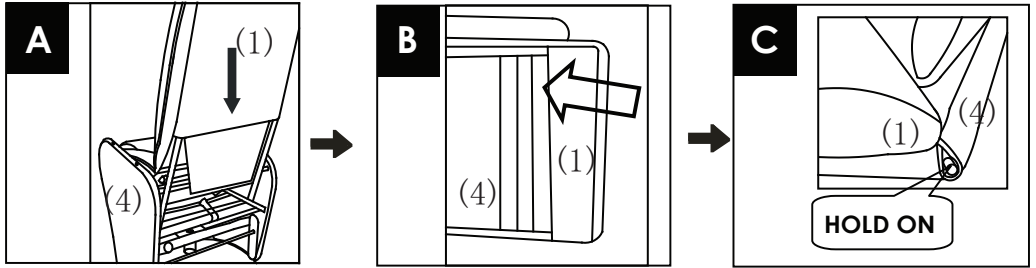

TIGHTENING BOLTS ON FRAME

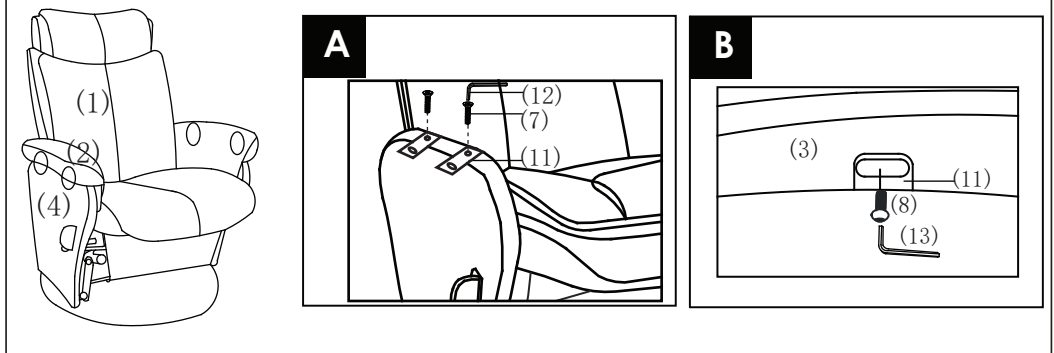

ASSEMBLING OTTOMAN

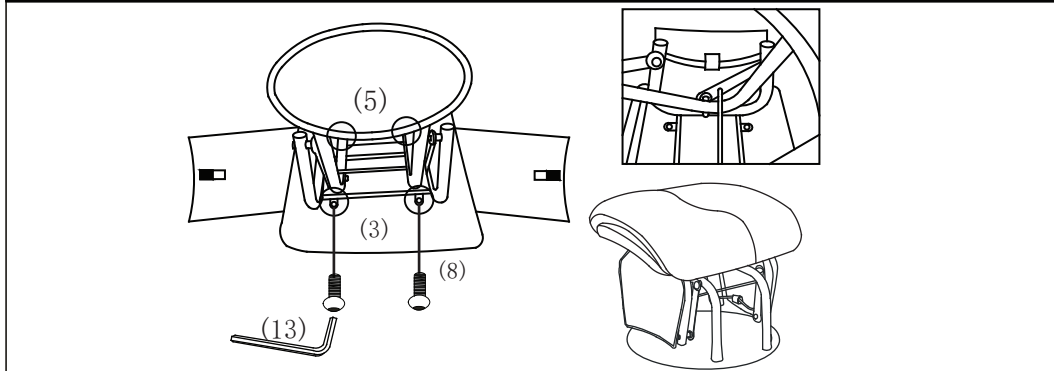

Warranty Against Defects

All Love N Care products are guaranteed for twelve months from the date of purchase. Our goods come with guarantees that cannot be excluded under the Australian Consumer Law.

You are entitled to a replacement or refund for a major failure and for compensation for any other reasonably foreseeable loss or damage.

You are also entitled to have the goods repaired or replaced if the goods fail to be of acceptable quality and the failure does not amount to a major failure. This covers against faults which develop through faulty materials and workmanship.

Misuse, accidental damages, normal wear and tear or neglect are not covered. If a fault becomes apparent, please return the item to the store of purchase with your receipt. You must inform the store what the defect is. We will then arrange for its repair or it will be

assessed for replacement as expediently as possible. The benefits of this warranty are in addition to other right and remedies under the law in relation to the goods or services to which this warranty relates.

If you are unable to return the item to the store of purchase, you can contact Love N Care on free call 1300 732 599.

Where you send the product directly to the manufacturer then you may be liable for the costs of transportation to and from Love N Care.

Love N Care will meet the reasonable expenses incurred by a consumer in making a warranty claim. You can claim expenses incurred in making a claim by contacting our customer service team on

1300 732 599 or by email at info@lovenecare.com.au

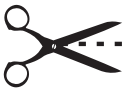

12 MONTH WARRANTY

CAYENNE GLIDER CHAIR

Please fill in this section to validate your warranty and send to: **297 Canterbury Rd Revesby NSW 2212**

Name: _____ Store Purchased: _____

Address: _____ Date Purchased: _____

Product Name/No. _____

Contact Us

Head Office:

Love N Care Pty Ltd.
297-299 Canterbury Rd, Revesby

NSW 2212 Australia

Contact No: 02 9774 4655

Fax: 02 9774 4633

Email: info@lovencare.com.au

Website: www.lovencare.com.au

loveⁿcare
lovencare.com.au

Let's be friends!

 <http://www.facebook.com/lovencare1>

 http://twitter.com/love_ncare



100 % AUSTRALIAN OWNED SINCE 1984